

evolution fires

SPECTRUM SERIES

44 - 50 - 60 - 72 - 82

OWNER'S MANUAL



WARNING

Read and understand this entire owner's manual, including all safety information, before plugging in or using this product. Failure to do so could result in fire, electric shock, or serious personal injury.

CAUTION

Keep this owner's manual for future reference. If you sell or give this product away, make sure this manual accompanies this product.

IMPORTANT SAFETY INFORMATION!

WARNING

When using electrical appliances basic precautions should always be followed to reduce the risk of fire, electric shock and injury to persons, including the following:

READ ALL THE INSTRUCTIONS BEFORE USING THIS APPLIANCE

- This heater is hot when in use. To avoid burning, do not touch hot surface. If provided, use handles when moving this heater. Keep combustible materials, such as furniture, pillows, bedding, papers, clothes, and curtains at least 1 m from the front of the heater and keep them away from the sides and rear. In order to avoid overheating, do not cover the heater.
 - Extreme caution is necessary when any heater is used near children or the infirm and whenever the heater is left operating and unattended.
 - Always unplug heater when not in use.
 - Do not operate any heater with a damaged cord or plug or after the heater malfunctions, has been dropped damaged in any manner, return heater to authorized service facility for examination, electrical or mechanical adjustment, or repair.
 - Indoor use only, do not use outdoors.
 - This heater is not intended for use in bathrooms, laundry areas and similar indoor locations. Never locate heater where it may fall into a bathtub or other water containers.
 - Do not run cord under carpeting. Do not cover cord with throw rugs, runners, or similar coverings. Arrange cord away from traffic area and where it will not be tipped over.
 - To disconnect heater, turn controls to off, then remove plug from outlet.
 - Do not inset or allow foreign objects to enter any ventilation or exhaust opening as this may cause an electric shock or fire or damage the heater.
 - To prevent a possible fire, do not block air intakes or exhaust in any manner. Do not use on soft surfaces, like a bed, where openings may become blocked.
 - A heater has hot and arcing or sparking parts inside. Do not use it in areas where gasoline, or flammable liquids are used or stored.
 - Use this heater only as describes in this manual. Any other use not recommended by the manufacturer may cause fire, electric shock, or injury to persons.
 - DANGER-High Temperatures may be generated under certain abnormal conditions. Do not partially or fully cover or obstruct the front of this heater.
 - Replacement of the lamps should be done only while the heater is disconnected from the supply circuit.
 - This appliance is not intended for use by persons (including children) with reduced physical, sensory or capabilities, or lack of experience and knowledge, unless they have been given supervision or instruction concerning use of the appliance by a person responsible for their safety. Children should be supervised to ensure that they do not play with the appliance.
 - CAUTION: In order to avoid a hazard due to inadvertent resetting of the thermal cut-out, this appliance must not be supplied through an external switching device, such as a timer, or connected to a circuit that is regularly switched on and off by the utility.
 - Electric sockets in residential rooms should comply with the 6/12 spacing requirements, this comes from the NEC and states that in a living area of a home, you must keep an electrical socket (outlet) 6 feet from any obstruction, or break in the wall, such as a doorway and no more than 12 feet from the previous electrical socket.
 - Whilst electric fires are very safe, we recommend you only plug into a mains socket, do not use an extension lead as the extension lead wire can get knocked, or overheat and become a hazard. You should never overload an extension lead or multiple extension leads.
- DO NOT REMOVE THE PLUG FROM THE APPLIANCE THIS WILL CANCEL YOUR WARRANTY**

Preparation













This product includes a GLASS panel! Always use extreme caution when handling glass. Failure to do so could result in personal injury or property damage.

Check the parts list to make sure nothing is missing. Dispose of packaging materials properly. Please recycle whenever possible.

You will need the following tools (not included): Phillips screwdriver; stud finder; level; tape measure; electric drill.

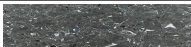
Parts and Hardware

 <p>A – Fireplace</p>				
	<p>B – Screws</p>		<p>C – Drywall anchors</p>	
 <p>D-Remote Control</p>				
	<p>E- Side Lights</p>	<p>F-Metal Bracket Semi embedded</p>	<p>F-Metal Bracket Fully embedded</p>	
 <p>G-Wall Bracket Fixed on back of fireplace</p>	 <p>H - Small Decorative Crystals</p>	 <p>I - Big Decorative Crystals</p>	 <p>J - Log set</p>	

Specification and Dimension

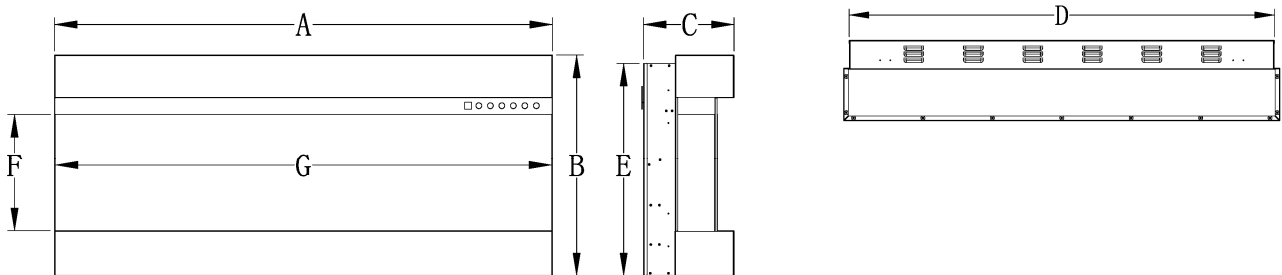

PRODUCT DIMENSIONS							
Model Number	A	B	C	D	E	F	G
EF-36WM	36.6" 93cm	19.1" 48.4cm	7.9" 20cm	35.5" 90.2cm	18.3" 46.56cm	10.1" 25.61cm	36.4" 92.57cm
EF-42WM	43.3" 110.2cm	19.1" 48.4cm	7.9" 20cm	42.2" 107.22cm	18.3" 46.56cm	10.1" 25.61cm	43.1" 109.6cm
EF-50WM	50" 127cm	19.1" 48.4cm	7.9" 20cm	48.9" 124.2cm	18.3" 46.56cm	10.1" 25.61cm	49.8" 126.57cm
EF-60WM	60" 152.4cm	19.1" 48.4cm	7.9" 20cm	58.9" 149.6cm	18.3" 46.56cm	10.1" 25.61cm	59.8" 151.97cm
EF-72WM	72" 182.8cm	19.1" 48.4cm	7.9" 20cm	70.9" 180cm	18.3" 46.56cm	10.1" 25.61cm	71.8" 182.37cm
EF-82WM	82" 208.2cm	19.1" 48.4cm	7.9" 20cm	80.9" 205.4cm	18.3" 46.56cm	10.1" 25.61cm	81.8" 207.77cm

Media Wall Installation and Assembly

Select a suitable location that is not susceptible to moisture and is away from drapes, furniture and high traffic-areas.

MEDIA WALL INSTALLATION

MINIMUM CLEARANCE TO COMBUSTIBLES

Due to the many different materials used on different walls, it is highly recommended that you consult your local builder before you install this appliance on the wall.

NOTE:

It is strongly recommended that all electrical sockets are installed behind the TV and all electrical work is carried out by a registered electrician.

Electricians by law should provide a Buildings Regulations Compliance Certificate (also known as a Part P Certificate)

Work carried out	Certificates issued	England - Building Control Notification required	Wales - Building Control Notification required
A new circuit has been installed.	Electrical Installation Certificate Building Regulations Compliance Certificate (also known as a Part P Certificate)	Yes	Yes
A fuse box/ consumer unit has been replaced.	Electrical Installation Certificate Building Regulations Compliance Certificate (also known as a Part P Certificate)	Yes	Yes
An existing circuit has been added to or altered in a room containing a bath, shower, swimming pool or sauna heater.	Minor Electrical Installation Works Certificate In many cases you will need a Building Regulations Compliance Certificate (also known as a Part P Certificate).	Yes	Yes
An existing circuit has been added to or altered. For example, in a kitchen or outdoors.	Minor Electrical Installation Works Certificate In many cases you will need a Building Regulations Compliance Certificate (also known as a Part P Certificate).	No	Yes
Electrical circuits are checked for deterioration or damage caused over time.	Electrical Installation Condition Report (EICR)	No	No

- A.** Select a location that is not prone to moisture and is located at least 36" (914mm) away from combustible materials such as curtain drapes, furniture, bedding, paper, etc.
- B.** Do not cut the plug off the power cable. If the plug is removed Evolution Fires will no longer honor the warranty.
- C.** The frame for the media wall must be hollow allowing air flow for the fire. If there is not enough airflow getting to the fire you will find the fire switches off this is happening because the fire is overheating and needs to cool down before switching back on. Continued use will break the appliance.
- D.** Check the fire is working before installation.

MEDIA WALL AIRFLOW & VENTALLATION

IMPORTANT ! **MORE AIR FLOW MORE HEAT**

If your are hiring a company to build your media wall or building your own follow the steps below to ensure the electric fire works efficiently without overheating.

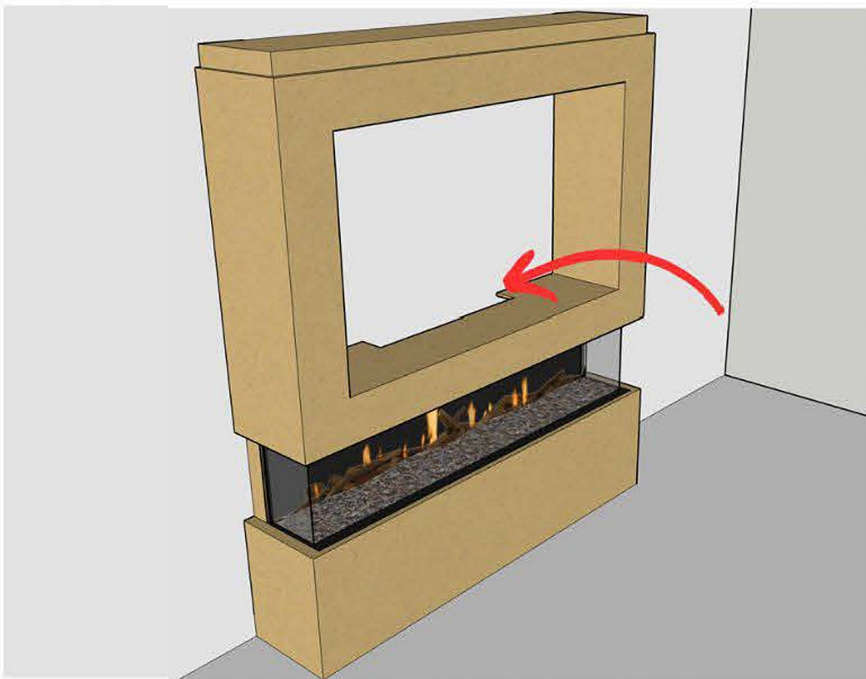

Leaving a letterbox cutout above the fire will ensure maximum airflow to the fire increasing its efficiency and will also prevent overheating.

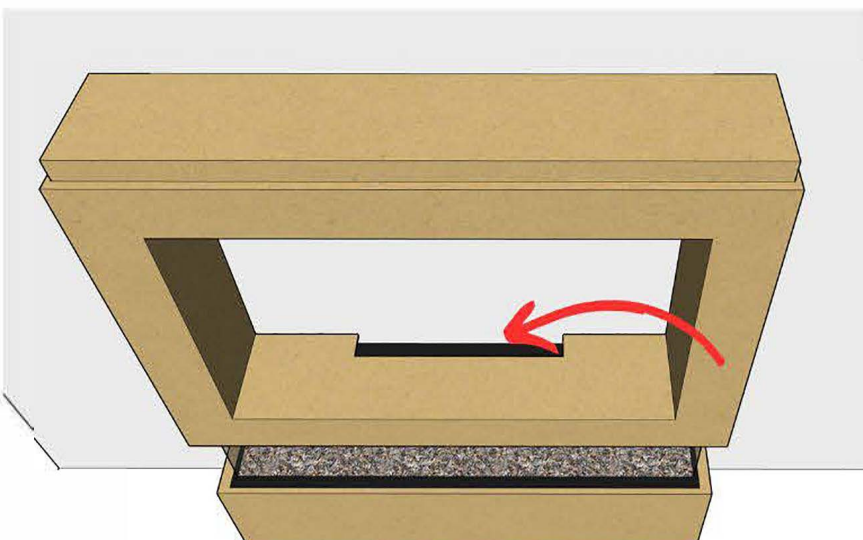

The cutout should be large enough to see the top of the fire.
Do not use ant type of silicone or filler to seal the in the media wall.

Installation Overview

Your appliance allows for three installation configurations.



One Sided

Glass exposed on the front only.

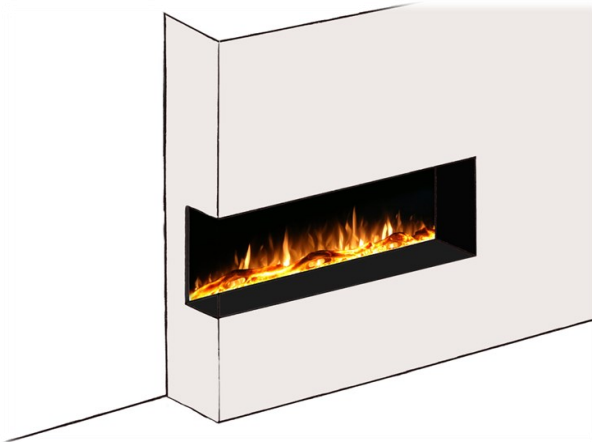

Two Sided

Glass exposed on the front and left or right sides.

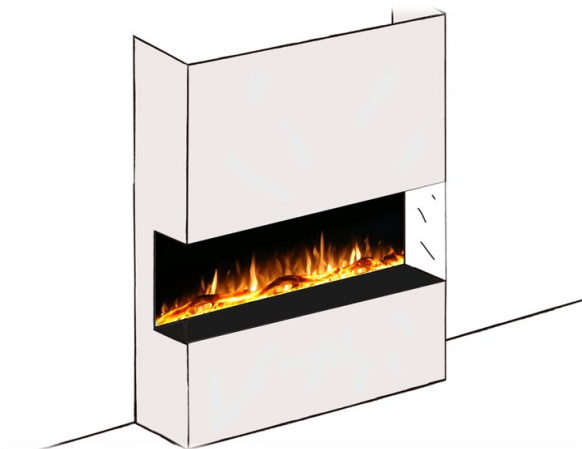

Three Sided

Glass exposed on the front, left and right sides.

Installation - Minimum Clearances

Your appliance is a recessed and/or mantel installed appliance. Select a suitable location that is not susceptible to moisture build-up. It must be located with enough distance away from flammable materials such as curtains, furniture and high traffic areas.

Note - Follow all local and national electrical regulations/codes.

Note - A frame can be constructed that is flush with the fire on the bottom and sides, as long as the vents on the fire unit are not obstructed and the frame is hollow to allow for air-flow.

Note - We recommend you don't place soft furnishings directly in front of the heater outlet.



Above the top of the fire must have a 100mm clearance to allow for air flow .

Not adding this clearance may cause the fire to over heat and switch off.

MEDIA WALL BUILD MINIMUM CLEARANCES (MM)

Bottom	0mm
Sides	0mm
Back	30mm
Top (see notes above)	200mm
Front (Measured from glass, plasterboard is exempt)	200mm

Installation-Rough Framing

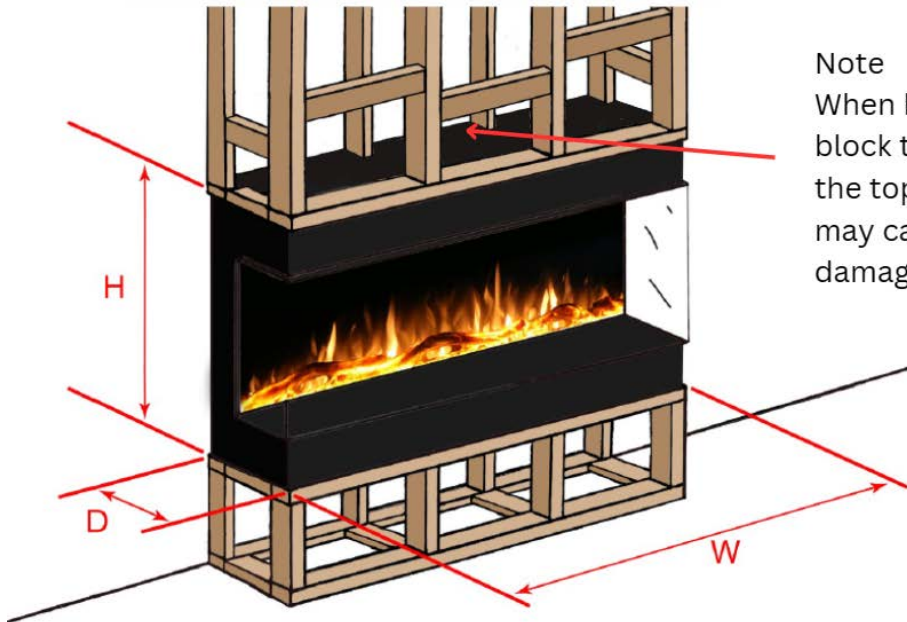

Note
When building the frame do not block the air vents positioned at the top back of the fire doing so may cause overheating and damage to your fire.

FRAMING DIMENSIONS (MM)			
MODEL NAME	W	H	D
EF-36WM	935	490	245
EF-42WM	1107	490	245
EF-50WM	1275	490	245
EF-60WM	1529	490	245
EF-72WM	1833	490	245
EF-82WM	2087	490	245

Note - The appliance is not load bearing. Carefully consider weight of finishing materials when constructing rough framing.

Note - Ensure installation complies with all local building codes and requirements.

Note - The framing dimensions above applies to all three types of installation. The illustration represents the three sided installation, but if one or two sided installation is preferred, simply extend the frame further on the closed glass side.

Installation - Plasterboard

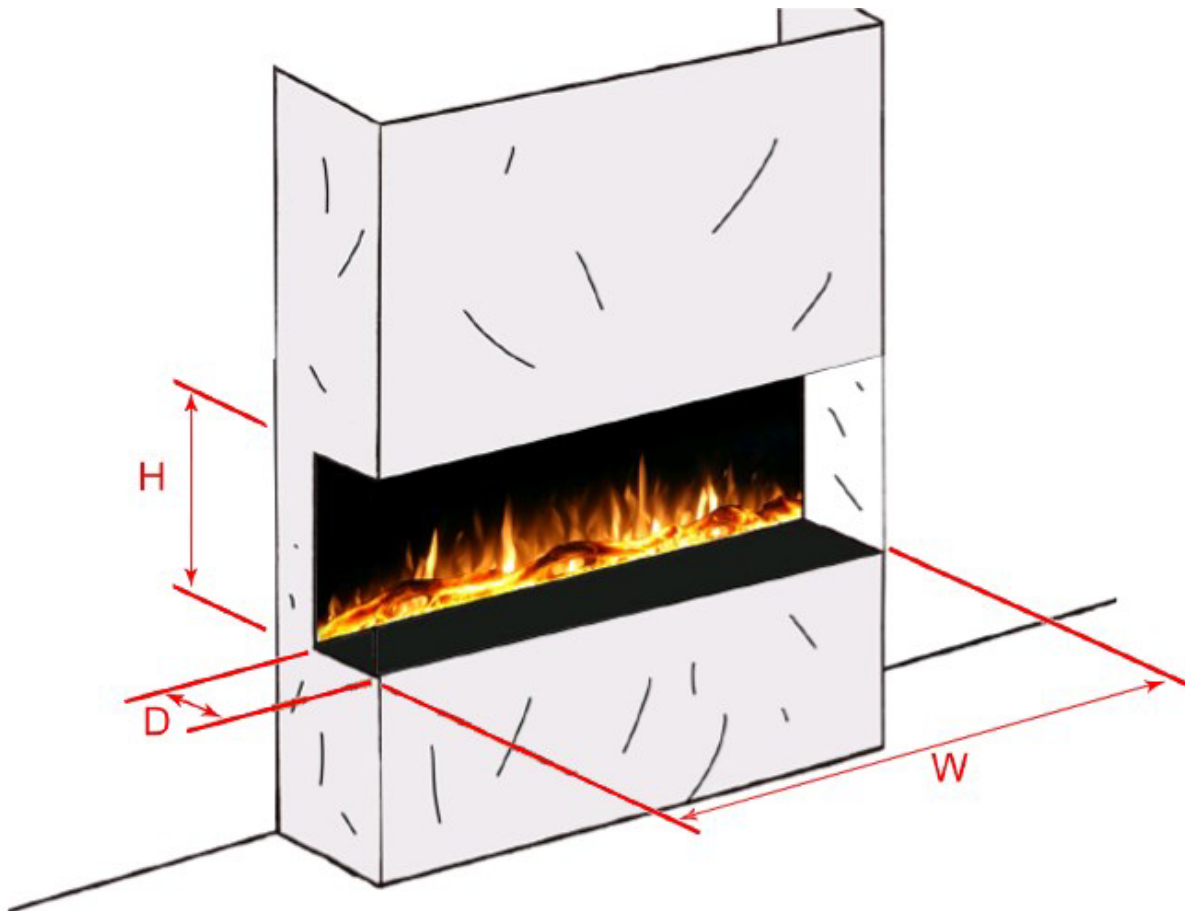

PLASTERBOARD RECESS DIMENSIONS (MM)			
MODEL NAME	W	H	D
EF-36WM	960	294	146
EF-42WM	1132	294	146
EF-50WM	1300	294	146
EF-60WM	1554	294	146
EF-72WM	1857	294	146
EF-82WM	2112	294	146

Note - Dimensions assuming the plasterboard is 12.5mm thick.

Installation-Preparation

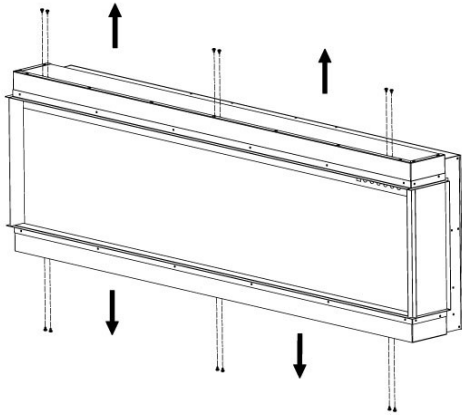

Fig.3-1

EF- 36", 42", 50" models have 4 brackets and 8 screws. EF-60", 72", 82" models have 6 brackets and 12 screws. Follow instructions below for your relevant model:

1. Remove the 8 (or 12) silver screws on the top and bottom of the appliance, see figure 3-1.



2. Install the 4 (or 6) 'L shape' metal brackets using the 8 (or 12) screws previously removed, see figure 3-2.

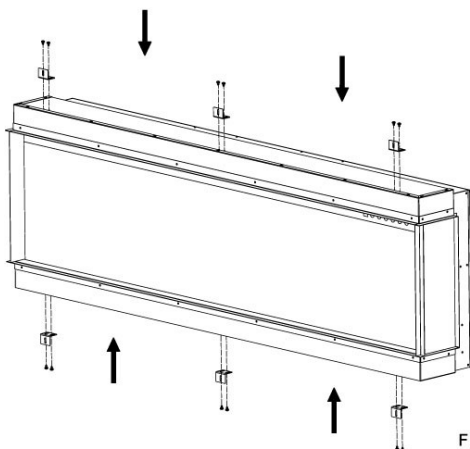
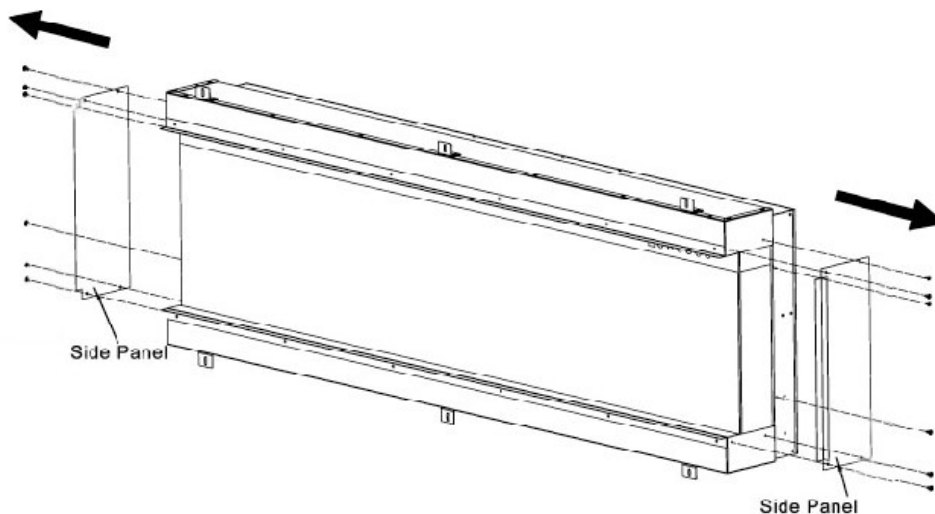

Fig.3-2

3. Remove the side panels from both sides by removing the 6 screws per panel, see figure below. Set them aside for now.



Installation-Choose your viewing style

Attach the relevant side panels or side trims to achieve your look.

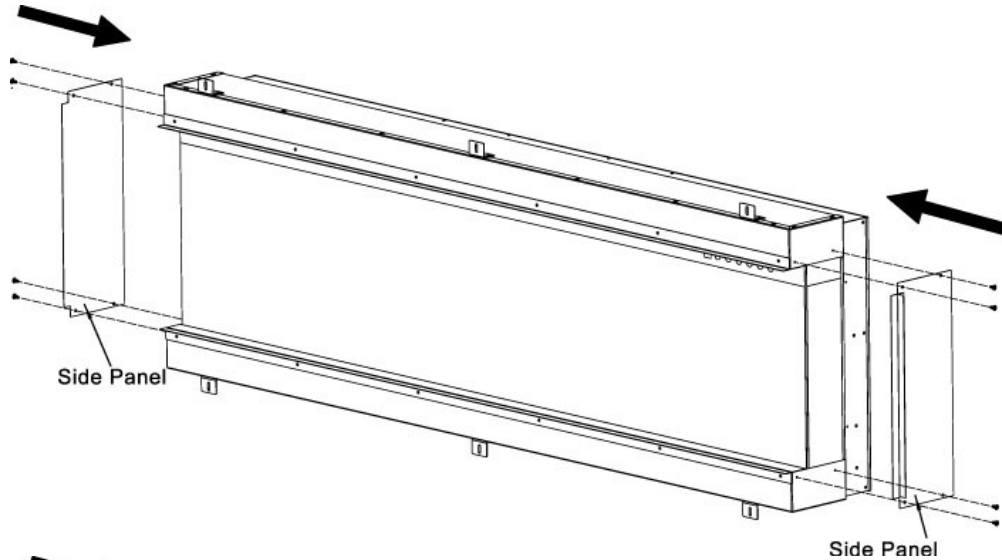

One sided

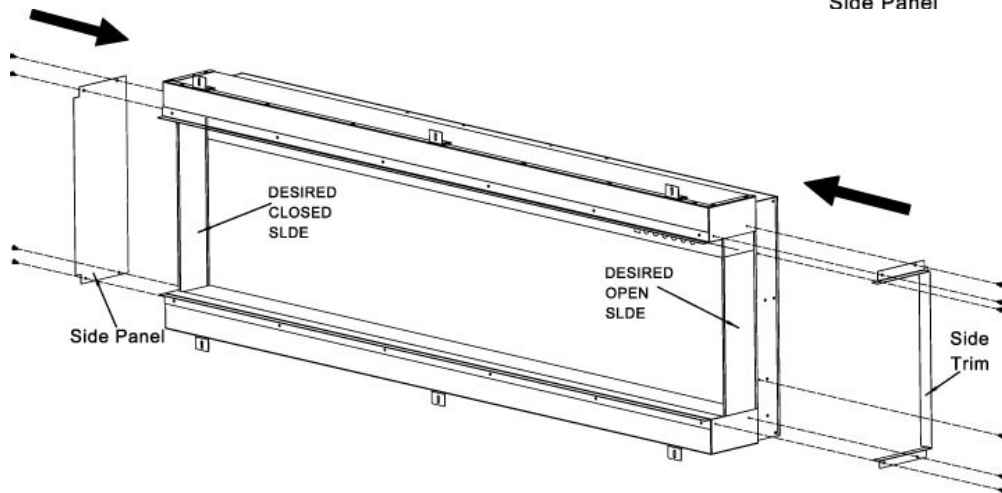

Two sided

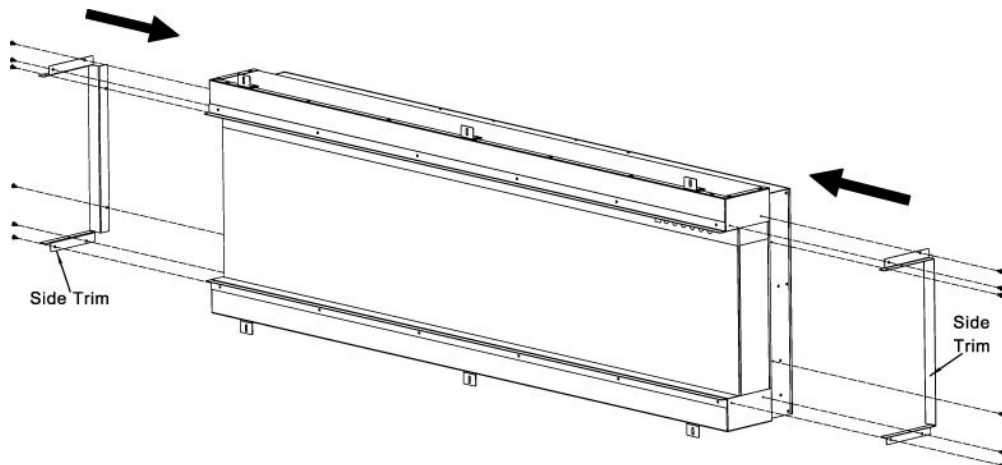

Three sided

SIDE LIGHTS INSTALLATION

Insert side lights as shown.

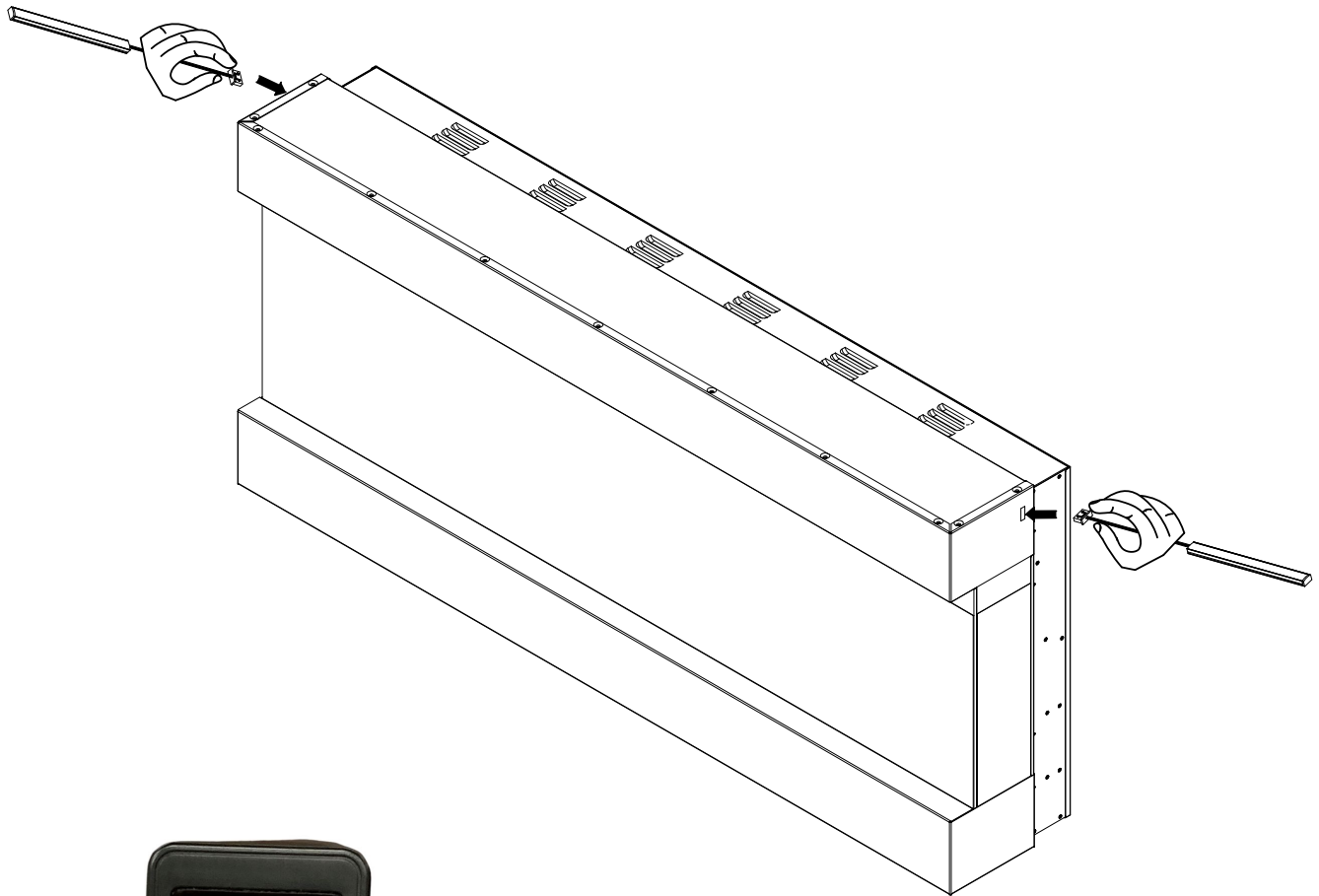

Side Light Colour Options

Installation of the front glass panel

Firstly remove the 4 screws which are fitted into the fireplace as shown



Unpack the glass screen, place it into the bottom tray and push backwards until the 4 tabs on the glass screen line up with screw holes.



Screw in the 4 screws which were removed in the first step.

Log-set / Crystal Ember Media Bed Installation

NOTE: Please use the information below to set out your media set based on the model you purchased.

A. The glass front must be removed and the appliance must be mounted in its final location before the log-set / crystals are installed.

B. Crystal Media Bed Placement

Carefully empty the bags of small crystals onto the plastic tray, see **Figure 1**.

Next place the large crystals on top of the small crystals and replace the glass, see **Figure 2**.

Figure 1.

Small Crystal Placement



Figure 2.

Large Crystal Placement



C. Log Media Bed Placement

1. Empty the crystal bags onto the plastic tray (shown in figure 1.)
2. Place the large logs on top of the crystals
3. Place the medium logs at either end of the media bed,
4. Place the twigs on top of the large logs.



Large Logs



Medium Logs



Twigs

Log Media Bed Placement



Operation



Please read the entire owner's manual, including **all safety information**, before plugging in or using this product. Failure to do so could result in **fire, electric shock, or serious personal injury**.

Power

Plug the power cord into a 220-240V 50Hz outlet (see **IMPORTANT SAFETY INFORMATION** on **Pages 2 and 3**). Make sure the outlet is in good condition and the plug is not loose. **NEVER** exceed the maximum amperage for the circuit. **DO NOT** plug other appliances into the same circuit.

AIR FLOW VENTS

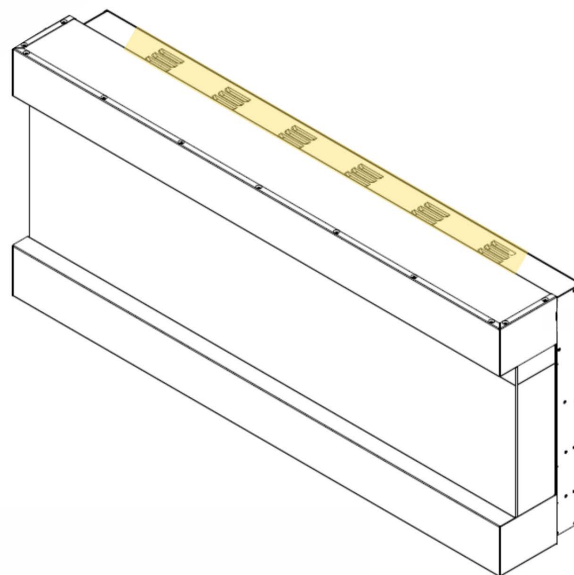
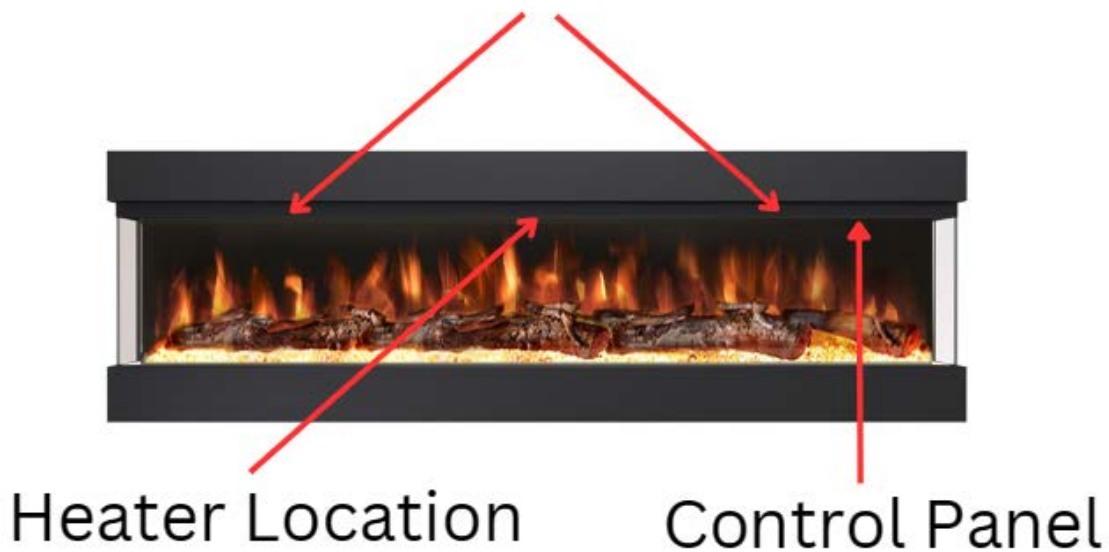

Top Vents

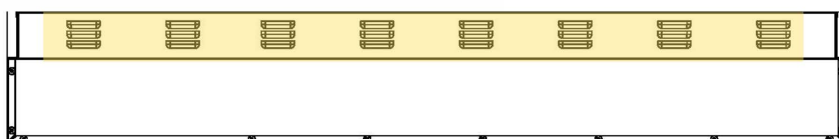

Operation



Read and understand this entire owner's manual, including **all safety information**, before plugging in or using this product. Failure to do so could result in **electric shock, fire, serious injury, or death.**

Power

Plug the power cord into grounded outlet (see **IMPORTANT SAFETY INFORMATION** on **Pages 2 and 3**). Make sure the outlet is in good condition and that the plug is not loose. **NEVER** exceed the maximum amperage for the circuit. **DO NOT** plug other appliances into the same circuit.

Methods of Operation





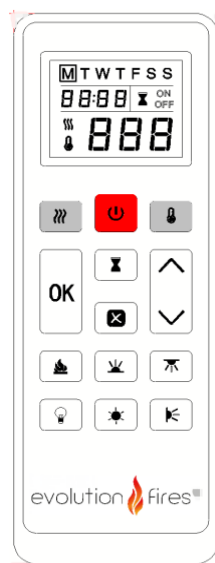

This electric fireplace can be operated by the TOUCH PANEL, located on the right side panel of the fireplace (see figure below), or by the battery-powered REMOTE CONTROL.

The operation and functions of the two methods are the same.







Before operating, please review the **IMPORTANT SAFETY INFORMATION** on **Pages 2 and 3**, and heed all warnings.

TOUCH SCREEN PANEL	REMOTE CONTROL
	

Touch Panel Operation



BUTTON	FUNCTION	ACTION & INDICATION																																													
 POWER	ON: Enables control panel functions and remote control. Turns on flame effect. OFF: Disables control panel functions and remote control. Turns off flame effect.	<ol style="list-style-type: none"> Press once. Indicator light turns on. Power turns on. All functions enabled. Press again. Flame effect turns off. Unit goes to standby. All functions turn off. 																																													
 TIMER	TIMER button: Controls timer settings to turn off fireplace at selected time. Settings range from 0.5 hours to 8 hours.	<ol style="list-style-type: none"> Press once. Indicator light turns on. Timer is set to 0.5 hours. Press again until desired setting is reached. Indicator lights show setting. 																																													
 FLAME	FLAME button: Makes flame effect dimmer and brighter. NOTE: Flame effect stays on until power button is turned off. Flame effect must be on for heater to turn on.	<ol style="list-style-type: none"> Press once. Flame brightness effect gets changing. Press again. until desired setting is reached. 																																													
 COLOR	COLOR button: Makes the color flame effect changing. NOTE: color effect stays on until power button is turned off. Color flame effect must be on for heater to turn on. NOTE: this fireplace is with memory function for flame.	<ol style="list-style-type: none"> Press once. Flame color effect gets changing. Press again until desired setting is reached. 																																													
 HEATER	HEATER button: Turns heater on and off. NOTE: The heater only works when the flame effect is on. If the flame effect is off, the heater will not turn on. NOTE: To prevent overheating, the heater fan will blow cool air for 8-10 seconds before the heater turns on, and after the heater turns off.	<ol style="list-style-type: none"> Press once. Indicator lights up. Fan blows cool air for 10 seconds. 750W heater turns on and blows warm air. Press again. Indicator lights up. 1500W heater turns on and blows hot air. Press again. Heaters turn off. The fan blows cool air for 10 seconds to allow heater to cool down, then turns off. 																																													
 TEMP	TEMPERATURE button: Turns heater on and off. NOTE: Press the button for 5 seconds, the temperature setting will switch from °C to °F. Same way from °F to °C.	<ol style="list-style-type: none"> Press once: Touch panel indicator becomes active. Press again: until desired setting is Reached. Digital display shows setting circles as below: 																																													
	<table border="1"> <thead> <tr> <th>Display</th> <th>0</th> <th>1</th> <th>2</th> <th>3</th> <th>4</th> <th>5</th> <th>6</th> <th>7</th> <th>8</th> <th>9</th> <th>10</th> <th>11</th> <th>12</th> <th>N</th> </tr> </thead> <tbody> <tr> <td>°C</td> <td>18</td> <td>19</td> <td>20</td> <td>21</td> <td>22</td> <td>23</td> <td>24</td> <td>25</td> <td>26</td> <td>27</td> <td>28</td> <td>29</td> <td>30</td> <td>C</td> </tr> <tr> <td>°F</td> <td>64</td> <td>66</td> <td>68</td> <td>70</td> <td>72</td> <td>74</td> <td>76</td> <td>78</td> <td>80</td> <td>82</td> <td>84</td> <td>86</td> <td>88</td> <td>F</td> </tr> </tbody> </table>		Display	0	1	2	3	4	5	6	7	8	9	10	11	12	N	°C	18	19	20	21	22	23	24	25	26	27	28	29	30	C	°F	64	66	68	70	72	74	76	78	80	82	84	86	88	F
Display	0	1	2	3	4	5	6	7	8	9	10	11	12	N																																	
°C	18	19	20	21	22	23	24	25	26	27	28	29	30	C																																	
°F	64	66	68	70	72	74	76	78	80	82	84	86	88	F																																	

Remote Control Operation

BUTTON	FUNCTION	ACTION & INDICATION
	<p>ON: Enables control panel functions and remote control. Turns on flame effect.</p> <p>OFF: Disables control panel functions and remote control. Turns off flame effect.</p>	<ol style="list-style-type: none"> Press once. Indicator light turns on. Power turns on. All functions enabled. Press again. Flame effect turns off. Power and all functions turn off.
	<p>COLOR button: Makes the color flame effect changing.</p> <p>NOTE: color effect stays on until power button is turned off. Color flame effect must be on for heater to turn on.</p>	<ol style="list-style-type: none"> Press once. Indicator light turns on. Flame color effect gets changing. Press again until desired setting is reached. Display window shows setting.
	<p>FLAME button: Makes flame effect dimmer and brighter.</p> <p>NOTE: Flame effect stays on until power button is turned off. Flame effect must be on for heater to turn on.</p>	<ol style="list-style-type: none"> Press once. Indicator light turns on. Flame brightness effect gets changing. Press again. until desired setting is reached.
 <p>HEATER</p>	<p>HEATER button: Turns heater on and off.</p> <p>NOTE: The heater only works when the flame effect is on. If the flame effect is off, the heater will not turn on.</p> <p>NOTE: To prevent overheating, the heater blows cool air for 10 seconds before the heater turns on, and after it turns off.</p>	<ol style="list-style-type: none"> Press once. Indicator lights up. Fan blows cool air for 10 seconds. Low heater turns on and blows warm air. Press again. Indicator lights up. High heater turns on and blows hot air. Press again. Heaters turn off. The fan blows cool air, then turns off.
	<p>LED Ember light button (1): Makes the color on bottom effect changing.</p> <p>NOTE: Ember color effect stays on until power button is turned off.</p>	<ol style="list-style-type: none"> Press once. Ember color effect gets changing. Press again. until desired setting is reached, in total 10 colors recycling. <p>11 level-Auto-cycle 12 level-off</p>
 <p>EMBER BRIGHTNESS</p>	<p>LED Ember light brightness button: Makes the LED ember lights on bottom effect gets changing.</p> <p>NOTE: LED Ember light brightness effect stays on until power button is turned off.</p>	<ol style="list-style-type: none"> Press once. LED ember light color effect gets changing. Press again until desired setting is reached. In total 5 levels. <p>From b4 - b3 - b2 - b1 - b5 - b4</p>
	<p>LED Side light button: Makes the LED side lights effect gets changing.</p>	<ol style="list-style-type: none"> Press once. Side light color effect gets changing. Press again. until desired setting is reached. <p>Cycle from 01-02-03-04-05-06-07-08-09-10-11-12 11 level-Auto-cycle 12 level off</p>

	<p>LED Down light button: Makes the color on TOP effect changing.</p> <p>NOTE: Down light color effect stays on until power button is turned off.</p>	<p>1. Press once. Down light color effect gets changing.</p> <p>2. Press again. until desired setting is reached.</p> <p>Cycle from 01-02-03-04-05-06-07-08-09-10-11-12</p> <p>“12” Down lights off</p>
---	---	---

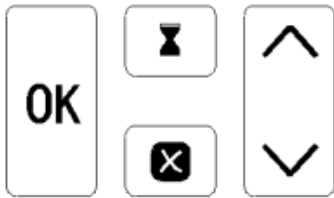
TIMER SETTINGS ON REMOTE CONTROL



 : Timer: Displays current day, time, and week. Press to enter or confirm timer settings.	
OK : Settings: Press to move to next step (use with Timer button). Press to confirm week timer.	
 : Back: Press to clear timer settings. Press to return to the previous step (use with Settings button).	
Up and Down (use with Settings button).	

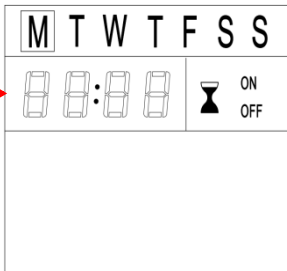

LCD Screen

<p>Weekday →</p> <p>Mon, Tues, Wed, Thurs, Fri, Sat, Sun</p>		<p>Note: The functions can only be adjusted when the related letters or digits are flashing.</p> <p>Note: Calibrate the timer to current time before the weekly settings.</p>
<p>Time Display →</p>		
<p>Current Time / Timer From 00: 00 to 24 NOTE: 00-12:00 is AM / 13:00-24:00 is PM</p>		



 TEMP	<p>TEMPERATURE button: Turns heater on and off.</p> <p>NOTE: Press & Hold the button for 5 seconds, the temperature setting will switch from °C to °F. Same way from °F to °C.</p>	<p>1. Press once: Indicator lights up. Temperature goes to 18 °C</p> <p>2. Press again: until desired setting is Reached. Digital display shows setting circles as below:</p>																																													
<table border="1"> <thead> <tr> <th>Display</th> <th>0</th> <th>1</th> <th>2</th> <th>3</th> <th>4</th> <th>5</th> <th>6</th> <th>7</th> <th>8</th> <th>9</th> <th>10</th> <th>11</th> <th>12</th> <th>N</th> </tr> </thead> <tbody> <tr> <td>°C</td> <td>18</td> <td>19</td> <td>20</td> <td>21</td> <td>22</td> <td>23</td> <td>24</td> <td>25</td> <td>26</td> <td>27</td> <td>28</td> <td>29</td> <td>30</td> <td>C</td> </tr> <tr> <td>°F</td> <td>64</td> <td>66</td> <td>68</td> <td>70</td> <td>72</td> <td>74</td> <td>76</td> <td>78</td> <td>80</td> <td>82</td> <td>84</td> <td>86</td> <td>88</td> <td>F</td> </tr> </tbody> </table>			Display	0	1	2	3	4	5	6	7	8	9	10	11	12	N	°C	18	19	20	21	22	23	24	25	26	27	28	29	30	C	°F	64	66	68	70	72	74	76	78	80	82	84	86	88	F
Display	0	1	2	3	4	5	6	7	8	9	10	11	12	N																																	
°C	18	19	20	21	22	23	24	25	26	27	28	29	30	C																																	
°F	64	66	68	70	72	74	76	78	80	82	84	86	88	F																																	

1 Set current day and time

- Press  once. When “MON” (Monday) begins flashing, use  to select the current day.
- Press **OK** . When the hour digits begin flashing, use  to select the current hour.



- Press **OK** again. When the minute digits begin flashing, use  to select the current minute.
- Press  again. The current time is now set.

2 Set ON/OFF time and temperature on a weekly cycle

- Press . When "MON" begins flashing, press **OK** 3 times. When "ON" begins flashing, use  to select the desired hour and minute to turn on the heater.  at any time to clear the digits and shut down "ON" timer.





note:

The timer can only be adjusted in 30-minute increments (i.e. 00:00 - 00:30; 00:30 - 01:00, etc.)

- Press **OK**. When "OFF" begins flashing, use  to select the desired hour and minute to turn off the heater. Press  at any time to clear the digits and shut down "OFF" timer.
- Press **OK** again. When "18" begins flashing, use  to select the desired temperature for Monday.

note:

If the temperature was previously set, those digits will be shown instead of "18".

- Press **OK** again. When "TUES" appears on the screen and "ON" begins flashing, use  to select the desired hour and minute to turn on the heater for Tuesday.
- Press **OK** again. When "OFF" begins flashing, use  to select the desired hour and minute to turn off the heater for Tuesday.
- Press **OK** again. When "18" begins flashing, use  to select the desired temperature for Tuesday.
- Repeat steps 1 to 6 to set the "ON/OFF" time and temperature for Wednesday, Thursday, Friday, Saturday, and Sunday.
- Press **OK** or  to complete programming, ensuring to aim the remote control at the receiver, located in the middle of the appliance. The appliance will "beep" once to confirm that programming has been successful.

Open window warning

If the room temperature decreases by 10 degrees within 3 minutes, the appliance will assume there is an open window nearby. In order to conserve energy, the heater will automatically switch from High Heat to Low Heat, or if the heater is already at Low Heat, it will turn off completely.

When switching from High Heat to Low Heat, the appliance will beep 3 times and the digital display will flash "88" 3 times before displaying the existing heating status.

When switching from Low Heat to Off, the appliance will beep 3 times and the digital display will flash "88" continuously.

To reset the heating function, see "operating remote control" section.

Care and Maintenance

Cleaning



ALWAYS turn the fireplace OFF and unplug the power cord from the outlet before cleaning, performing maintenance, or moving this fireplace. Failure to do so could result in electric shock, fire, or personal injury.



NEVER immerse in water or spray with water. Doing so could result in electric shock, fire, or personal injury. **ALWAYS** turn the fireplace OFF and unplug the power cord from the outlet before cleaning, performing maintenance, or moving this fireplace. Failure to do so could result in electric shock, fire, or personal injury.

Metal:

- Buff using a soft cloth, slightly dampened with a citrus oil-based product.
- DO NOT use brass polish or household cleaners as these products will damage the metal trim.

Glass:

- Use a good quality glass cleaner sprayed onto the cloth or towel. Dry thoroughly with a paper towel or lint-free cloth.
- **NEVER** use abrasive cleansers, liquid sprays, or any cleaner that could scratch the surface.

Vents:

- Use a vacuum or duster to remove dust and dirt from the fireplace and vent areas.

Plastic:

- Wipe gently with a slightly damp cloth and a mild solution of dish soap and warm water.
- **NEVER** use abrasive cleansers, liquid sprays, or any cleaner that could scratch the surface.

Maintenance



Risk of electric shock! DO NOT OPEN any panels ! No user-serviceable parts inside!



ALWAYS turn the fireplace OFF and unplug the power cord from the outlet before cleaning, performing maintenance, or moving this fireplace. Failure to do so could result in electric shock, fire, or personal injury. **DO NOT OPEN any panels ! No user-serviceable parts inside!**

Electrical and Moving Parts:

- The fan motors are lubricated at the factory and will not require lubrication.
- Electrical components are integrated in the fireplace and are not serviceable by the consumer.

Storage:

- Store fireplace in a clean dry place when not in use.



WARNING! NO SERVICING of the internal or electrical parts should be performed by the consumer. Do not service the unit yourself.



DO NOT CUT THE PLUG OFF FROM THE POWER CABLE DOING THIS MAY RESULT IN YOUR GUARANTEE BEING VOID

NOTICE

When the fireplace is first turned on, a slight odor may be present. This is normal and should not occur again unless the fireplace is not used for a long period of time.

NOTICE

To improve operation, **aim** the remote control at the front of the fireplace. **DO NOT press the buttons too quickly.** Give the unit time to respond to each command.

Temperature Limiting Control

This heater is equipped with a Temperature Limiting Control. Should the heater reach an unsafe temperature, the heater will automatically turn OFF. To reset:

1. Unplug the power cord from the outlet.
2. Turn the ON/OFF switch on the CONTROL PANEL to OFF. **Wait 5 minutes.**
3. Inspect the fireplace to make sure no vents are blocked, or clogged with dust or lint. If they are, use a vacuum to clean the vent areas.
4. With the POWER switch in the OFF position, plug the power cord back into the outlet.
5. If the problem continues, have your outlet and wiring inspected by a professional.

Remote Control Battery Information

- This remote control uses two AAA **battery (not included).**
- Instructions for battery installation are on the Remote Control battery compartment.



NEVER dispose of batteries in a **fire.** Failure to observe this precaution **may result in an explosion.** Dispose of batteries at your local hazardous material processing center.

Troubleshooting/ FAQ

<u>Problem</u>	<u>Possible Cause</u>	<u>Solution</u>	<u>Note</u>
Fire not turning on	Fire not plugged in or switched on at socket	Check plug is correctly fitted into socket and the socket is turned on.	If all solutions have been tested and problem persists, a new control panel is required.
	Fuse blown	Disconnect plug and inspect the fuse. Replace with a 13A fuse if broken.	
	Faulty control panel	If the controls do not work, press each control continuously one at a time. After a few cycles, the controls should recognize the input and work correctly.	
Noisy heater	Fan clogged	Remove the heating unit and remove dust from fan.	If all solutions have been tested and problem persists, a new heating element/ fan assembly is required.
	Fan unbalanced/ catching on housing	Manually re-center fan on each side. Check fan is not warped or damaged.	
Heater only blowing cold air	Fan clogged	Remove the heating unit and remove dust from fan.	If all solutions have been tested and problem persists, a new heating element/ fan assembly is required.
	Faulty heating element	Inspect the heating element and make sure all wires are firmly connected.	
	Faulty fan motor	Fan may be rotating too slow.	
No flame picture/ partial flame picture	Loose connection	Ensure all wires are connected firmly.	If all solutions have been tested and problem persists, a new PCB is most likely required.
	LED blown (If partial flame picture)	Test the faulty LED strip using another LED power connector that you know works. If LED strip still doesn't work, the fault is most likely with the LED strip and not the PCB. New LED strip required.	
	Damaged PCB	New PCB required.	

Heater cutting out	Build-up of hot air	Ensure inlets and outlet are free from obstruction and there are sufficient clearances surrounding the unit.	If problem persists, the installation will need assessed to ensure it adheres to all required minimum clearances as stated in this manual.
	Thermostat setting causing heater to cut-out	Adjust thermostat setting on remote to maintain desired room temp or deactivate thermostat setting.	-
Heater switching on without activation	Thermostat set to keep room at certain temperature.	Adjust thermostat setting to maintain desired room temp or deactivate thermostat setting.	If all solutions have been tested and problem persists, a new PCB is required.
	Thermostat faulty	Replace PCB	

NOTE: Wiring and exploded diagrams to assist with fire repair are available on request.

Product Warranty

Your Product is guaranteed for one year from the date of purchase.

Should this product prove defective within one year of purchase due to a design fault, workmanship or material breakdown, the product will be repaired or replaced free of charge.

Product warranty is subject to the following conditions:

- The product is to be used for domestic purposes only in accordance with the operating instructions.
- Responsibility of proof of purchase lies with the end user(s) who must prove product purchase within 12 month period of claim date.
- All warranties will be invalidated if unauthorized repairs or modifications are made to the electric fire, or in case of accident, misuse or damage caused by improper installation, or damage occurring during transit to or from the repairer.
- This warranty does not apply to heating elements, bulbs or fuses within this product

Your rights under this guarantee are additional to your statutory rights, which in turn are not affected by this guarantee.